

iSpaze[®]

iSpaze Smart Solutions Pvt. Ltd.
(An NIT Alumni Start-Up, Recognized by Govt. of India & Govt of UP)

MADE IN INDIA



iSpaze[®]

iSpaze Smart Solutions Pvt. Ltd.

(An NIT Alumni Start-Up, Recognized by Govt. of India & Govt. of UP)



iSpaze is an Indian IoT and electronics R&D company, established in 2020 and based in Ghaziabad, Uttar Pradesh. We specialize in the development and manufacturing of Smart Touch Switch Boards and smart automation solutions designed for the Indian market.

Our solutions are fully compatible with existing modular switch boxes, ensuring easy installation and seamless upgrades.

We empower brands with white-labeled IoT solutions through our complete Product DDM (Design, Development & Manufacturing) model, enabling companies to launch smart products without maintaining technical resources or infrastructure.

Our Vision

"To lead the smart products industry with innovation, quality, and trust"

Our Mission

"Without compromising on quality, we strive to provide the most affordable, reliable, and secure home automation solutions."



iSpaze[®]

Why iSpaze

All Core Technologies – Made in India by iSpaze

IoT Server

 In-house developed server ensuring data security, faster response & reliability.

Mobile Apps

 Smart control at your fingertips with apps designed & developed by iSpaze.

Firmware (Code)

 Custom-developed firmware for seamless integration and long-term stability.

PCB (Hardware)

 Engineered & manufactured in India for durability and quality assurance.

powered by 



Easy To
Install

OWN
R&D



PROUDLY
MADE IN

भारत

Easy
Reparable **No**
Re-Wiring

Indian
Server

RGB
Back Light

Capacitive
Touch

OWN CLOUD SERVER (HOSTED OVER AWS MUMBAI, INDIA)

iSpaze®

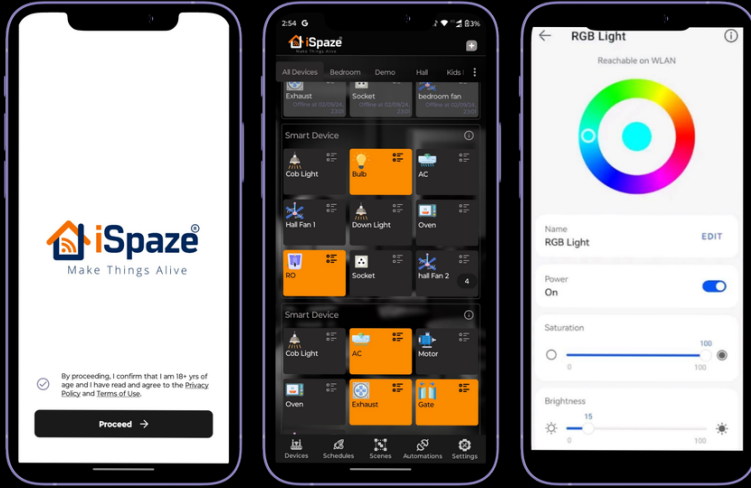

All in One Mobile App For Home Automation

SCHEDULE CONTROL

SCENES CONTROL

SHARING CONTROL

GET IT ON
Google Play

Download on the
App Store

Voice Assistant Integration

No smart home system is complete without voice assistant integration. iSpaze products support seamless connectivity with Amazon Alexa and Google Voice Assistant (GVA), enabling users to control their appliances effortlessly through simple voice commands.



WORKS WITH
amazon alexa

works with
Google Home

Smart Remote Control



- Master Off All Switches
- Ergonomic Design
- RGB Backlight Control
- Humming Less FAN Speed Control
- Wi-Fi Reset
- Factory Reset

powered by  aws

iSpaze[®]

Smart Touch Switch Board

LUXURY | COMFORT | SAFETY

Luxury Tempered Glass Panel

Crafted with precision and elegance, this premium tempered glass panel is twice as strong as conventional glass. With smooth rounded edges, it resists heat, scratches, smudges, and moisture while allowing effortless fingerprint removal.

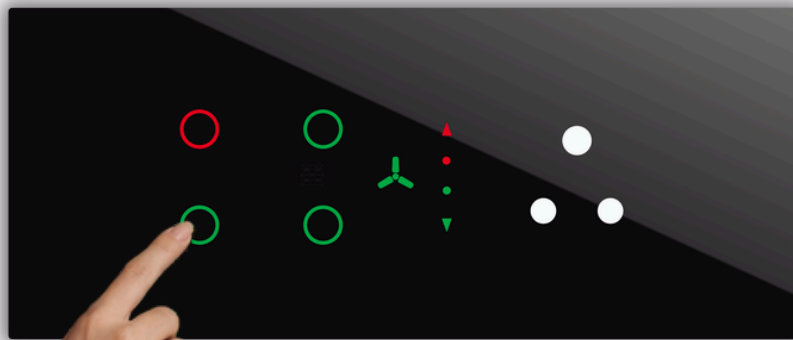

- 3 MM TEMPERED GLASS WITH BEVELED EDGES
- REAL ELECTROPLATED METALLIC EDGES
- ENGINEERED WITH A PREMIUM METALLIC BACK PLATE

Available Technologies

Remote Based | Remote+Wi-Fi | Remote + Zigbee

Available Colours

Black ● White ● Grey ●

Available Material : Acrylic & Glass

Available Size : 2M to 18M



METAL BASE FRAME PLATES



Smart Touch Switch Board

LUXURY | COMFORT | SAFETY

- No need to break the wall.
- No need to change the wiring.
- Metal Box Size : (3"x3").

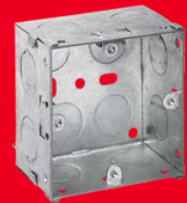

Size :- 2 Modular

RGB
Back Light

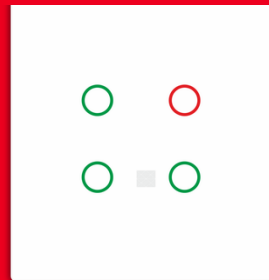
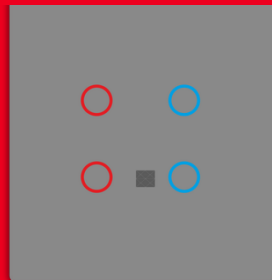
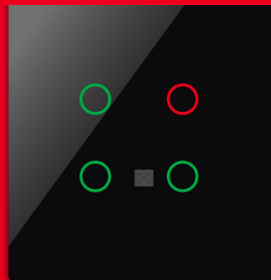

2M4S- 4 Switch Control

App
Control

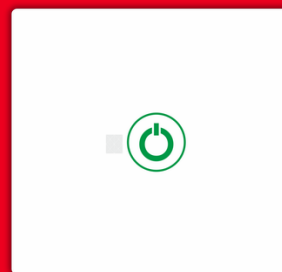
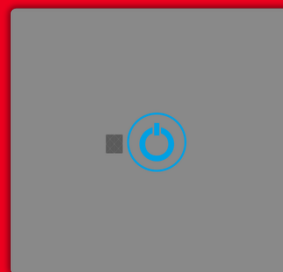

2M1H-1 Heavy Switch

Voice
Control

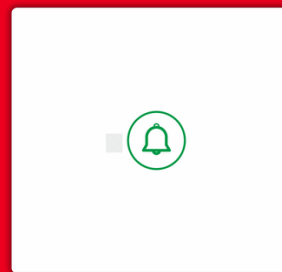
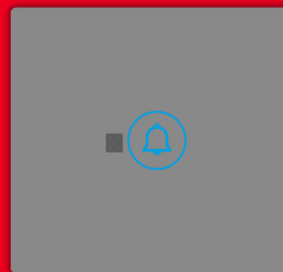
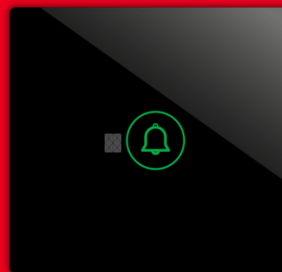

2MDB-Door Bell

Remote
Control

Schedule
Control

Scene
Control

UPS
Support

Feather
Touch

Custom
Icons

Heavy
Load

Child
Lock

Dimmer
Support

Size	Configuration	Code	MRP (INR)	
			Acrylic	Glass
2M-3 BY 3	4 Switch	2M4S	7990	9990
	1 Heavy Switch	2M1H	7990	9990
	Door Bell	2MDB	4990	7990

PROUDLY
MADE IN
भारत



Smart Touch Switch Board

LUXURY | COMFORT | SAFETY

- No need to break the wall.
- No need to change the wiring.
- Metal Box Size : (5"x3")



Size :- 4 Modular

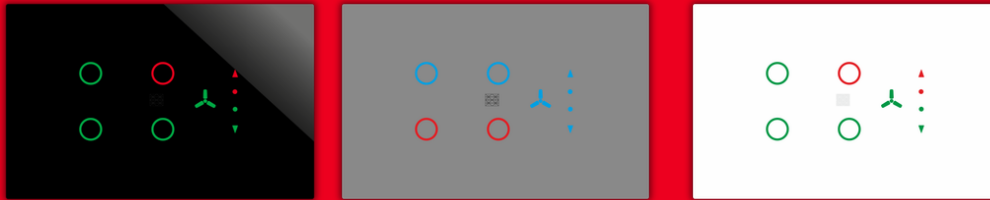

4M4S1F- 4 Switch 1 FAN Control

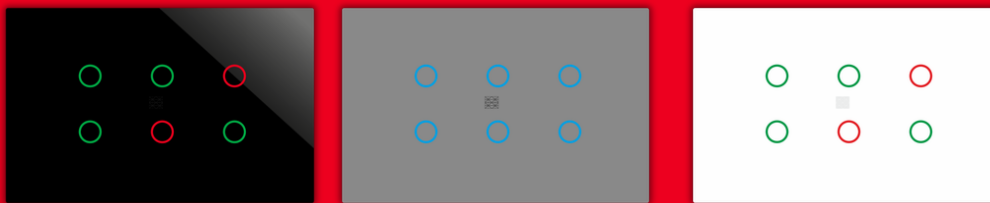

4M6S-6 Switch Control

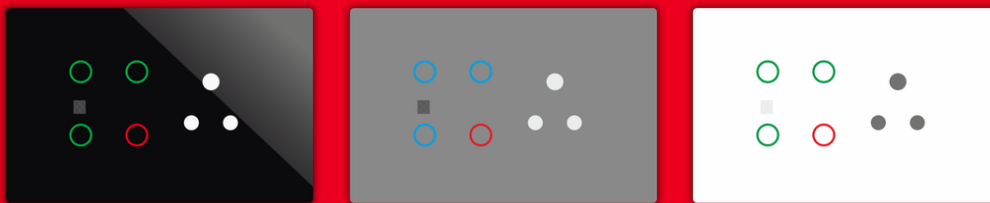

4M4S1Skt- 4 Switch 1 Socket Control

Size	Configuration	Code	MRP (INR)	
			Acrylic	Glass
4M-5 BY 3	6 Switch	4M6S	9990	10990
	4 Switch 1 Fan	4M4S1F	9990	10990
	4 Switch 1 Socket	4M4S1SKT	9990	10990

PROUDLY
MADE IN
भारत



RGB
Back Light

App
Control

Voice
Control

Remote
Control

Schedule
Control

Scene
Control

UPS
Support

Feather
Touch

Custom
Icons

Heavy
Load

Child
Lock

Dimmer
Support

Smart Touch Switch Board

LUXURY | COMFORT | SAFETY

- No need to break the wall.
- No need to change the wiring.
- Metal Box Size : (8"x3")



Size :- 6 Modular

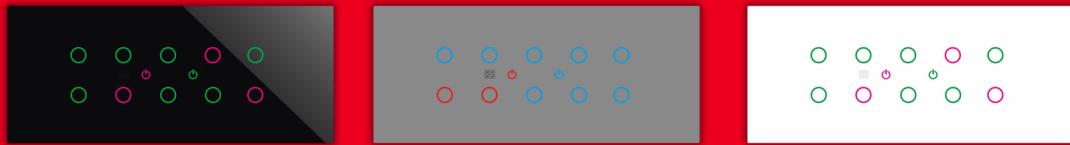

6M10S- 10 Switch 2 Scenes

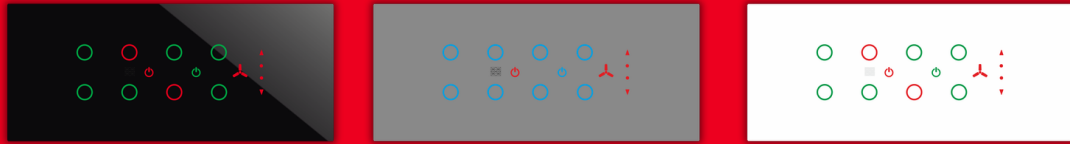

6M8S1F- 8 Switch 1 Fan 2 Scenes

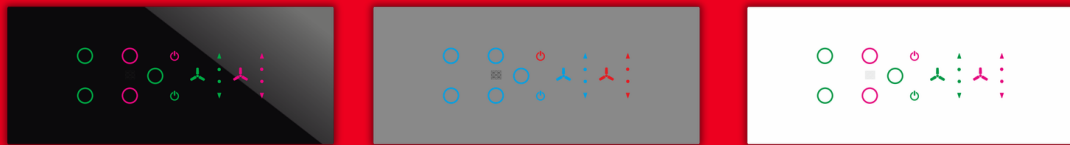

6M5S2F- 5 Switch 2 Fan 2 Scenes

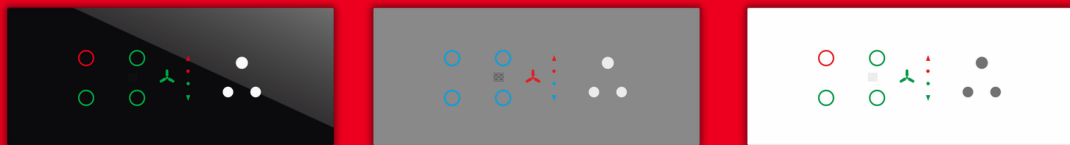

6M4S1F1Skt- 4 Switch 1 FAN 1Socket

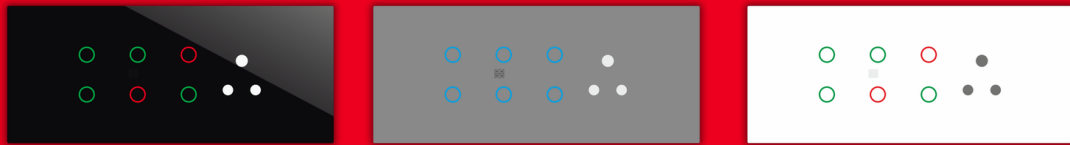

6M6S1Skt- 6 Switch 1Socket

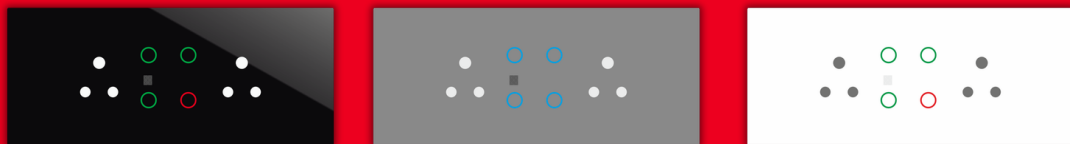

6M4S2Skt - 4 Switch 2 Socket

RGB
Back Light

App
Control

Voice
Control

Remote
Control

Schedule
Control

Scene
Control

UPS
Support

Feather
Touch

Custom
Icons

Heavy
Load

Child
Lock

Dimmer
Support

Size	Configuration	Code	MRP (INR)	
			Acrylic	Glass
6M-8 BY 3	10 Switch Control	6M10S	11990	12990
	8 Switch 1 Fan Control	6M8S1F	11990	12990
	5 Switch 2 Fan	6M5S2F	11990	12990
	4 Switch 1 Fan 1 Socket	6M4S1F1SKT	11990	12990
	6 Switch 1 Socket	6M6S1SKT	11990	12990
	4 Switch 2 Socket	6M4S2SKT	11990	12990

Smart Touch Switch Board

LUXURY | COMFORT | SAFETY

- No need to break the wall.
- No need to change the wiring.
- Metal Box Size : (9"x3")



Size :- 8 Modular

- RGB Back Light
- App Control
- Voice Control
- Remote Control
- Schedule Control
- Scene Control

- UPS Support
- Feather Touch
- Custom Icons
- Heavy Load
- Child Lock
- Dimmer Support

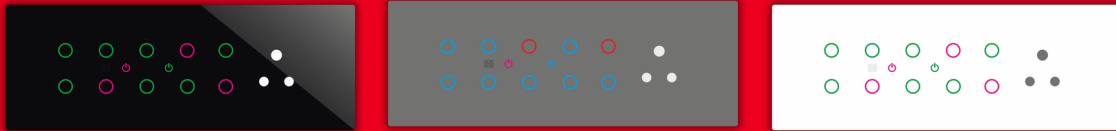

8M10S1Skt-10 Switch 1 Socket 2 Scenes



8M8S1F1Skt-8 Switch 1Fan 1 Socket 2 Scenes

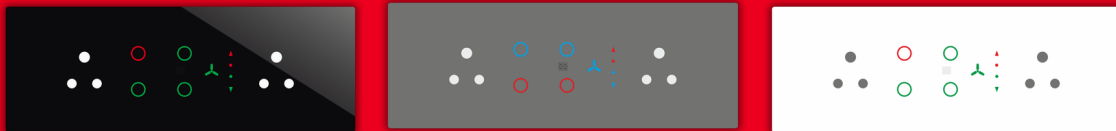

8M4S1F2Skt-4 Switch 1 Fan 2 Socket

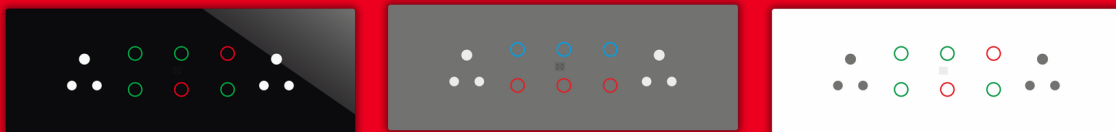

8M6S2Skt-6 Switch 2 Socket

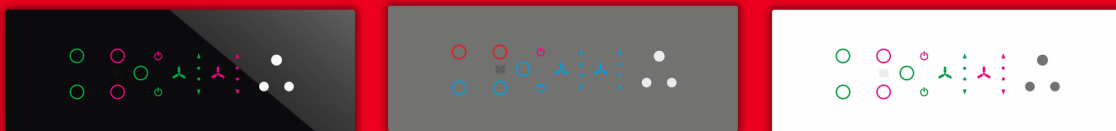

8M5S2F1Skt-5 Switch 2 Fan 1 Socket 2 Scenes

Size	Configuration	Code	MRP	
			Acrylic	Glass
8M- 9 BY 3	10 Switch 1 Socket	8M10S1SKT	12990	14990
	8 Switch 1 Fan 1 Socket	8M8S1F1SKT	12990	14990
	5 Switch 2 Fan 1 Socket	8M5S2F1SKT	12990	14990
	4 Switch 1 Fan 2 Socket	8M4S1F2SKT	12990	14990
	6 Switch 2 Socket	8M6S2SKT	12990	14990



Smart Touch Switch Board

LUXURY | COMFORT | SAFETY

- No need to break the wall.
- No need to change the wiring.
- Metal Box Size : (8"x6")



Size :- 12 Modular

RGB
Back Light

App
Control

Voice
Control

Remote
Control

Schedule
Control

Scene
Control

UPS
Support

Feather
Touch

Custom
Icons

Heavy
Load

Child
Lock

Dimmer
Support

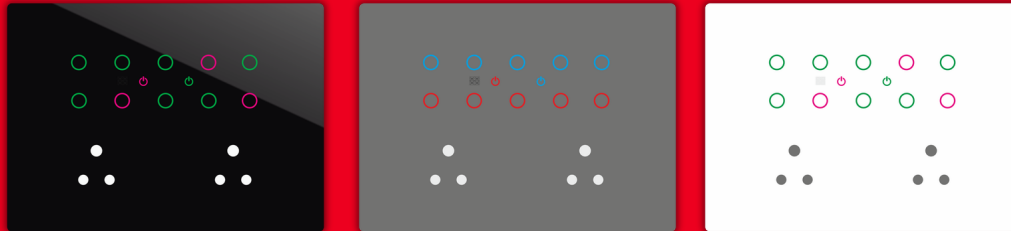

12M10S2Skt-10 Switch 2 Socket 2 Scenes

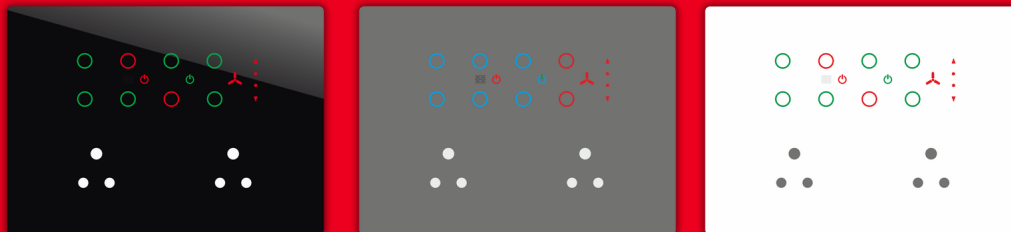

12M8S1F2Skt-8 Switch 1 Fan 2 Socket 2 Scenes

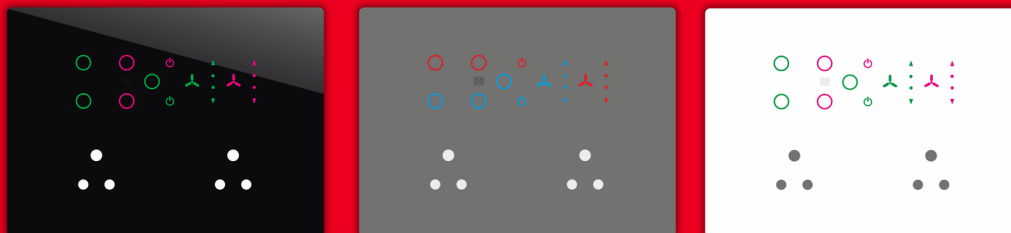

12M5S2F2Skt-5 Switch 2 Fan 2 Socket 2 Scenes

Size	Configuration	Code	MRP	
			Acrylic	Glass
12 M-8 BY 6	10 Switch 2 Socket	12M10S2SKT	14990	16990
	8 Switch 1 Fan 2 Socket	12M8S2SKT	14990	16990
	5 Switch 2 Fan 2 Socket	12M5S2F2SKT	14990	16990
16M/18M	10 Switch 2 Socket	16/18M10S2SKT	16990	18990
	8 Switch 1 Fan 2 Socket	16/18M8S2SKT	16990	18990
	5 Switch 2 Fan 2 Socket	16/18M5S2F2SKT	16990	18990



While touch panels elevate your primary spaces, our glass plates ensure that secondary switchboards maintain the same elegant aesthetic, creating a seamless and unified interior theme.

GLASS PLATES

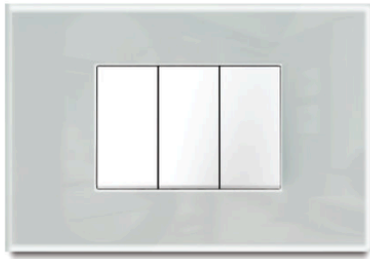

ANTIQUE WHITE

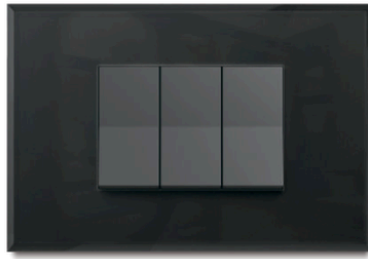

OREO BLACK

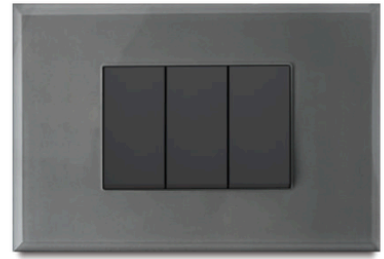

RHINO GREY

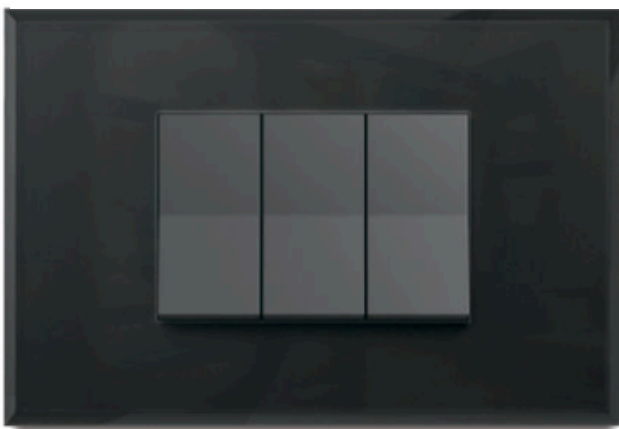

METAL BASE FRAME PLATES

- ✓ Uniform premium look throughout the house
- ✓ Crafted with high-quality tempered glass
- ✓ Ideal for secondary switchboards
- ✓ Cost-effective upgrade solution
- ✓ Matches perfectly with touch panels
- ✓ Scratch-resistant & easy-to-clean surface

CODE	MODULE	MRP GLASS PLATES		
		ANTIQUE WHITE	OREO BLACK	RHINO GREY
4001	1M	1020.00	1020.00	1020.00
4002	2M	1020.00	1020.00	1020.00
4003	3M	1388.00	1388.00	1388.00
4004	4M	1855.00	1855.00	1855.00
4005	6M	2532.00	2532.00	2532.00
4006	7M	2567.00	2567.00	2567.00
4007	8M(SQ)	2858.00	2858.00	2858.00
4008	8M(HZ)	2858.00	2858.00	2858.00
4009	9M	2916.00	2916.00	2916.00
4010	12M	3395.00	3395.00	3395.00
4011	14M	3500.00	3500.00	3500.00
4012	16M	3733.00	3733.00	3733.00
4013	18M(HZ)	3850.00	3850.00	3850.00
4014	18M(SQ)	4140.00	4140.00	4140.00
4015	21M	4200.00	4200.00	4200.00

iSpaze®

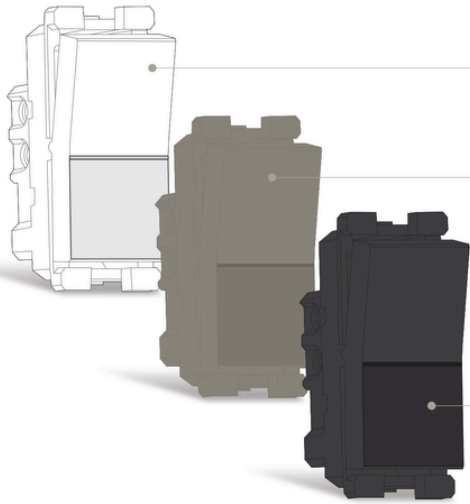

" Designed to perfectly complement our Glass Touch Switch Boards."



CODE	ITEM	₹ MRP WHITE	₹ MRP CHARCOAL BLACK & NEBULA GREY	PKG	MASTER CARTON
------	------	----------------	--	-----	------------------

ERICA SWITCHES

10A. SWITCHES 240V~ 1 MODULE

with  mark

3001	10A. 1 WAY SWITCH	90.00	102.00	20	800
3002	10A. 2 WAY SWITCH	178.00	215.00	20	800
3003	10A. BELL PUSH SWITCH	178.00	215.00	20	800
3004	10A. 1 WAY SWITCH WITH INDICATOR	202.00	242.00	20	800
3005	10A. BELL PUSH SWITCH WITH INDICATOR	225.00	270.00	20	800

16A. SWITCHES 240V~ 1 MODULE

with  mark

3006	16A. 1 WAY SWITCH	252.00	302.00	20	800
3007	16A. 2 WAY SWITCH	275.00	330.00	20	800
3008	16A. 1 WAY SWITCH WITH INDICATOR	296.00	356.00	20	800

10A. & 16A. SWITCHES 240V~ 2 MODULE

with  mark

3011	10A. 1 WAY SWITCH	273.00	328.00	10	400
3012	16A. 1 WAY SWITCH	315.00	379.00	10	400
3013	10A. 2 WAY SWITCH	315.00	379.00	10	400
3014	10A. BELL PUSH SWITCH	293.00	352.00	10	400
3015	10A. BELL PUSH WITH INDICATOR	359.00	431.00	10	400
3016	16A. 2 WAY SWITCH	379.00	456.00	10	400

32A. DP SWITCHES 240V~ 2 MODULE

with  mark

3021	32A. DP SWITCH WITH INDICATOR	633.00	759.00	10	400
------	-------------------------------	--------	--------	----	-----

CODE	ITEM	₹ MRP WHITE	₹ MRP CHARCOAL BLACK & NEBULA GREY	PKG	MASTER CARTON
------	------	----------------	--	-----	------------------



3502 3503 3506

6A. & 16A. SOCKET 2 MODULE

with  mark

3502	6A. 3 PIN SOCKET	266.00	320.00	10	400
3503	6A. 3 PIN SOCKET WITH SHUTTER	297.00	356.00	10	400
3506	6-16A. 5 PIN MULTI SOCKET WITH SAFETY SHUTTER	457.00	547.00	10	400



3511 3512 3514 3515

DIMMER & REGULATOR

3511	SWITCH TYPE DIMMER (450W)	726.00	869.00	10	400
3512	4 STEP SWITCH TYPE REGULATOR (80W)	726.00	869.00	10	400
3514	SOCKET TYPE DIMMER (450W)	946.00	1133.00	10	400
3515	5 STEP SOCKET TYPE REGULATOR (80W)	883.00	1058.00	10	400

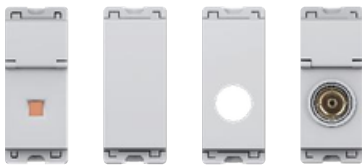

3521 3522 3523 3524

MODULAR ACCESSORIES 1 MODULE

3521	6A. NEON INDICATOR (WW)	262.00	321.00	20	800
3522	BLANK PLATE	55.00	67.00	20	800
3523	CABLE OUTLET WITH HOLE	120.00	144.00	10	400
3524	TV ANTENNA SOCKET	221.00	265.00	10	400
3530	RJ-11 2 LINE 2 PORT TELEPHONE JACK	378.00	454.00	10	400
3531	RJ-11 2 LINE 1 PORT TELEPHONE JACK WITH SHUTTER	353.00	425.00	10	400
3532	RJ-11 4 LINE 2 PORT TELEPHONE JACK	416.00	500.00	10	400
3533	RJ-45 ,MODEM JACK FOR COMPUTER LUCANT AT & † CAT-6 WITH SHUTTER	1070.00	1287.00	10	400



3530 3531 3532 3533



3535 3536 3537 3538

NEW

HDMI & USB 1 MODULE

3535	HDMI	1574.00	1889.00	10	400
3536	A TYPE USB CHARGER OUTPUT 5V-2.5A	1574.00	1889.00	10	400
3537	C TYPE USB CHARGER OUTPUT 5V-2.5A	1580.00	1901.00	10	400
3538	C TYPE USB FAST CHARGER OUTPUT 9V-4A	2614.00	3136.00	10	400

CODE	ITEM	₹ MRP WHITE	₹ MRP CHARCOAL BLACK & NEBULA GREY	PKG	MASTER CARTON
------	------	----------------	--	-----	------------------

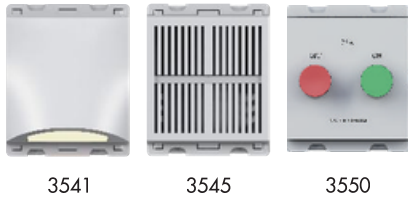
NIGHT LAMP, BUZZER & MOTOR STARTER 2 MODULE

3541	LED NIGHT LAMP (WW)	756.00	908.00	10	400
3545	BUZZER BELL	629.00	756.00	10	400
3550	SINGLE PHASE MOTOR STARTER (25/32A)	1322.00	1588.00	10	400

6A. TO 32A. SP MCB 1 MODULE

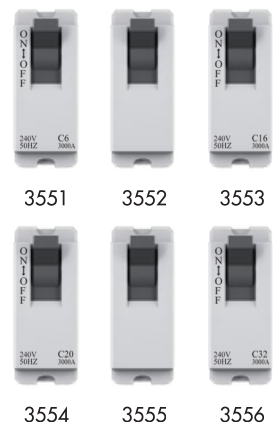
 with  mark

3551	6A. S.P. MCB	503.00	605.00	10	400
3552	10A. S.P. MCB	503.00	605.00	10	400
3553	16A. S.P. MCB	503.00	605.00	10	400
3554	20A. S.P. MCB	503.00	605.00	10	400
3555	25A. S.P. MCB	503.00	605.00	10	400
3556	32A. S.P. MCB	503.00	605.00	10	400

6A. TO 32A. DP MCB 2 MODULE

 with  mark

3557	6A. D.P. MCB	1197.00	1437.00	10	400
3558	10A. D.P. MCB	1197.00	1437.00	10	400
3559	16A. D.P. MCB	1197.00	1437.00	10	400
3560	20A. D.P. MCB	1197.00	1437.00	10	400
3561	25A. D.P. MCB	1197.00	1437.00	10	400
3562	32A. D.P. MCB	1197.00	1437.00	10	400



Wi-Fi Smart Curtain Motor

Rated Torque	1.2 N·m
No-load Speed	50 rpm
Operating Voltage	100–240 VAC
Frequency	50/60 Hz
Rated Current	0.25 A
Rated Power	12 W
Linear Speed	14 cm/s
Duty Cycle	S2 2 min
Dimensions	29 × 7 × 5 cm
Noise	< 45 dB(A)
Ingress Protection	IP20
Remote Frequency	433 MHz
Wireless Protocol	2.4 GHz (Wi-Fi)
Recommended Load Maximum	≤ 35 kg
Load Breaking Load	50 kg*
	Level E4 (Grade 4)



Curtain Motor MRP-8900/-

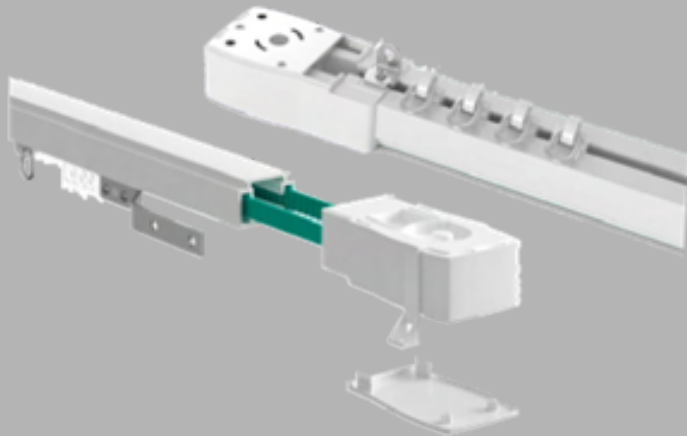

Custom Curtain Track (Per Feet / Center & Single Opening)
Includes Drivers & Accessories
MRP- 890/-

Curtain Remote (2 Channel) MRP- 1550/-



Wi-Fi

zigbee

5-WIRE

RS-485

Compatible with:



- Only manufacturing defects are covered under warranty.
- Damage due to misuse, unauthorised repair, or installation errors are excluded.
- Post-warranty expiration, the product remains eligible for chargeable service support.

CAUTION

Never recommended to use maximum load. Always stick to recommended load.



Face recognition Smart lock



- Face recognition
- Fingerprint unlocking
- Password
- IC card
- Mechanical key
- Remote unlocking

- Emergency Power Interface: Type-C USB
- Unlocking Methods: Facial Recognition / Palm Print Recognition / Fingerprint / PIN Code / Card / Key / Mobile App
- Operating Temperature Range: -20°C ~ 60°C
- Power Supply: Lithium Battery (3200 mAh)
- Compatible Door Thickness: 40-120 mm
- Capacity: 100 (Face + Palm Print) | 100 (PIN Codes) | 100 (Cards)
- Features: Virtual PIN Code Support, Low Battery Alarm
- Integrated Video Doorbell & Peephole Camera
- Material: Aluminum Alloy
- Compatible Door Types: Wood / Steel / Stainless Steel / Aluminum / Brass

MRP - 16990 / -

Cob, Panel Led Drivers



7-15W Cob, Panel Led Drivers Driver
(ZigBee / 0.1% Dim + CCT)



16-24 W Cob, Panel Led Drivers Driver (ZigBee / 0.1% Dim + CCT)



LED Strip Controller 15A (ZigBee / Dim
+ CCT / 5V-24V)



LED Strip Controller 15A (ZigBee /
RGB + CCT / 5V-24V)

MRP-2590/-

iSpaze Sense



MOTION SENSOR PIR CEILING

360 Degree 220V Ceiling-Mount White PIR Motion Sensor Switch with LUX Sensor In-built Energy Saving Sensor, LUX Adjustment, Time Adjustment, Automatic Sensor



MOTION SENSOR PIR CEILING

180 Degree Wall-Mount PIR Motion Switch , White



MOTION SENSOR PIR FALSE CEILING

IS-10- Pir Motion Sensor with Light Sensor, Energy Saving Detector Switch (Fall/Recessed Ceiling Mounted)



MOTION SENSOR PIR WALL HANGGING

IS-11-180` Wall-Mount PIR Motion Switch(Multiple Angle Rotatable) , White

Hotel Automation



Energy Saving Switch for Hotels

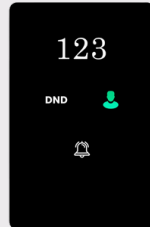

Hotel DND Touch Panel



RFID Card Readers



RFID Card

Sliding Gate Automation

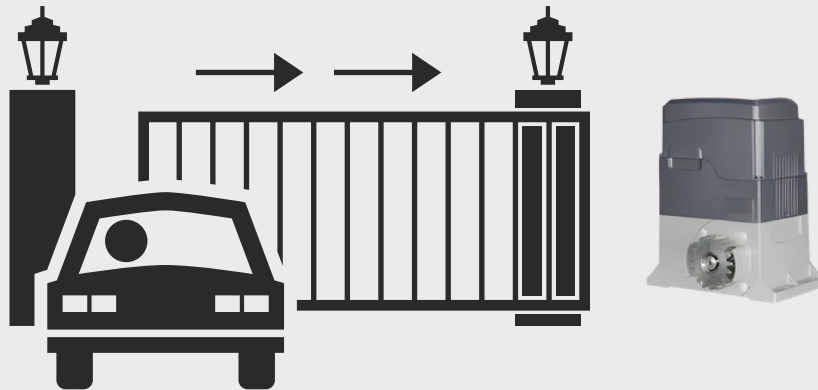

"Experience Seamless Gate Automation with Our Powerful Motor"

Staircase Controller Sensor

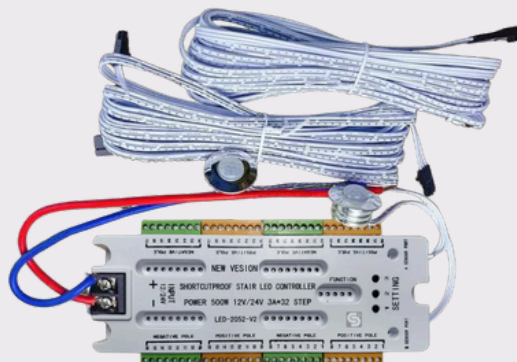

iSpaze[®]

Manufactured & Marketed

iSpaze Smart Solutions Pvt. Ltd.

(An NIT Alumni Start-Up, Recognized by Govt. of India & Govt of UP)

Plot No.- 29, Khasra No-38, Sobhagya Puram - II
Govindpuram, Ghaziabad- UP- 201013
www.ispaze.in | +91-9412802472



Dealer Stamp

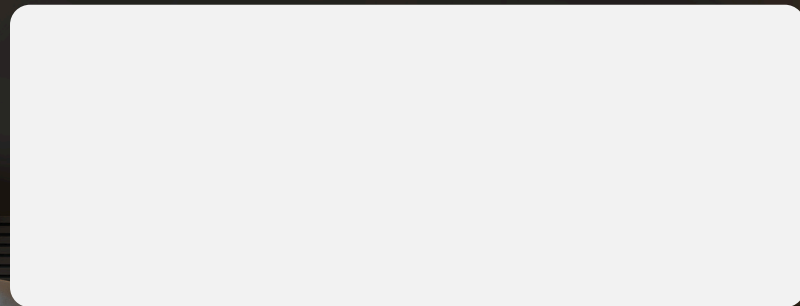

Follow us :

